



Education

PCI Express Impact on Storage Architectures and Future Data Centers

Ron Emerick, Oracle Corporation

- The material contained in this tutorial is copyrighted by the SNIA.
 - Member companies and individual members may use this material in presentations and literature under the following conditions:
 - ◆ Any slide or slides used must be reproduced in their entirety without modification
 - ◆ The SNIA must be acknowledged as the source of any material used in the body of any document containing material from these presentations.
 - This presentation is a project of the SNIA Education Committee.
 - Neither the author nor the presenter is an attorney and nothing in this presentation is intended to be, or should be construed as legal advice or an opinion of counsel. If you need legal advice or a legal opinion please contact your attorney.
 - The information presented herein represents the author's personal opinion and current understanding of the relevant issues involved. The author, the presenter, and the SNIA do not assume any responsibility or liability for damages arising out of any reliance on or use of this information.
- NO WARRANTIES, EXPRESS OR IMPLIED. USE AT YOUR OWN RISK.**

PCI Express Impact on Storage Architectures and Future Data Centers

- PCI Express Gen2 and Gen3, IO Virtualization, FCoE, SSD are here or coming soon. This session describes PCI Express, Single Root and Multi Root IOV and the implications on FCoE, SSD and impacts of all these changes on storage connectivity, storage transfer rates. The potential implications to the Storage Industry and Data Center Infrastructure will also be discussed. This tutorial will provide the attendee with:
 - ◆ Knowledge of PCIe Architecture, PCIe Roadmap, System Root Complexes and IO Virtualization
 - ◆ Expected Industry Roll Out of latest IO Technology and required Root Complex capabilities
 - ◆ Implications and Impacts of FCoE, SSD and IO to storage Connectivity
 - ◆ IO Virtualization connectivity possibilities in the Data Center (via PCIe)

- **IO Architectures**
 - ◆ PCI Express is Here to Stay
 - ◆ PCI Express Tutorial
 - ◆ New PCI Express based architectures
 - ◆ How does PCI Express work
- **IO Evolving Beyond the Motherboard**
 - ◆ Serial Interfaces
 - › InfiniBand, 10 GbE, 40 GbE, 100 GbE
 - › PCIe IO Virtualization
 - ◆ Review of PCI Express IO Virtualization
 - ◆ Impact of PCI Express on Storage

I/O Architecture

- **PCI provides a solution to connect processor to IO**
 - ◆ Standard interface for peripherals – HBA, NIC etc
 - ◆ Many man years of code developed based on PCI
 - ◆ Would like to keep this software investment
- **Performance keeps pushing IO interface speed**
 - ◆ PCI/PCI-X 33 Mhz, 66 Mhz to 133 Mhz
 - ◆ PCI-X at 266 Mhz released
 - › Problems at PCI-X 512 Mhz with load and trace length
- **Parallel interfaces are almost all replaced**
 - ◆ ATA/PATA to SATA
 - ◆ SCSI to SAS
 - (UWDIS may finally be gone)
- **Move parallel PCI has migrated to serial PCI Express**

PCI Express Introduction

- PCI Express Architecture is a high performance, IO interconnect for peripherals in computing/ communication platforms
- Evolved from PCI and PCI-X™ Architectures
 - ◆ Yet PCI Express architecture is significantly different from its predecessors PCI and PCI-X
- PCI Express is a serial point- to- point interconnect between two devices (4 pins per lane)
- Implements packet based protocol for information transfer
- Scalable performance based on the number of signal Lanes implemented on the interconnect

PCI Express Overview

- **Uses PCI constructs**
 - ◆ Same Memory, IO and Configuration Model
 - ◆ Identified via BIOS, UEFI, OBP
 - ◆ Supports growth via speed increases
- **Uses PCI Usage and Load/ Store Model**
 - ◆ Protects software investment
- **Simple Serial, Point- to- Point Interconnect**
 - ◆ Simplifies layout and reduces costs
- **Chip- to- Chip and Board-to-Board**
 - ◆ IO can exchange data
 - ◆ System boards can exchange data
- **Separate Receive and Transmit Lanes**
 - ◆ 50% of bandwidth in each direction

PCIe What's A Lane

Point to Point Connection Between Two PCIe Devices

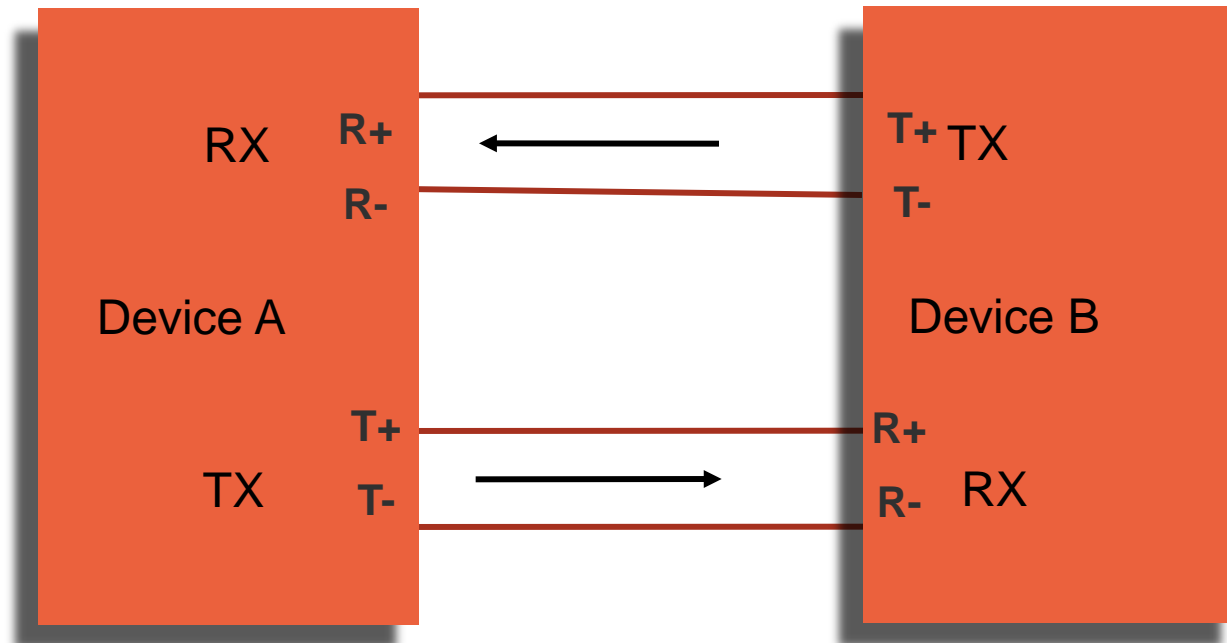

This Represents a Single Lane Using Two Pairs of Traces,
 TX of One to RX of the Other

PCIe – Multiple Lanes

Links, Lanes and Ports – 4 Lane (x4) Connection

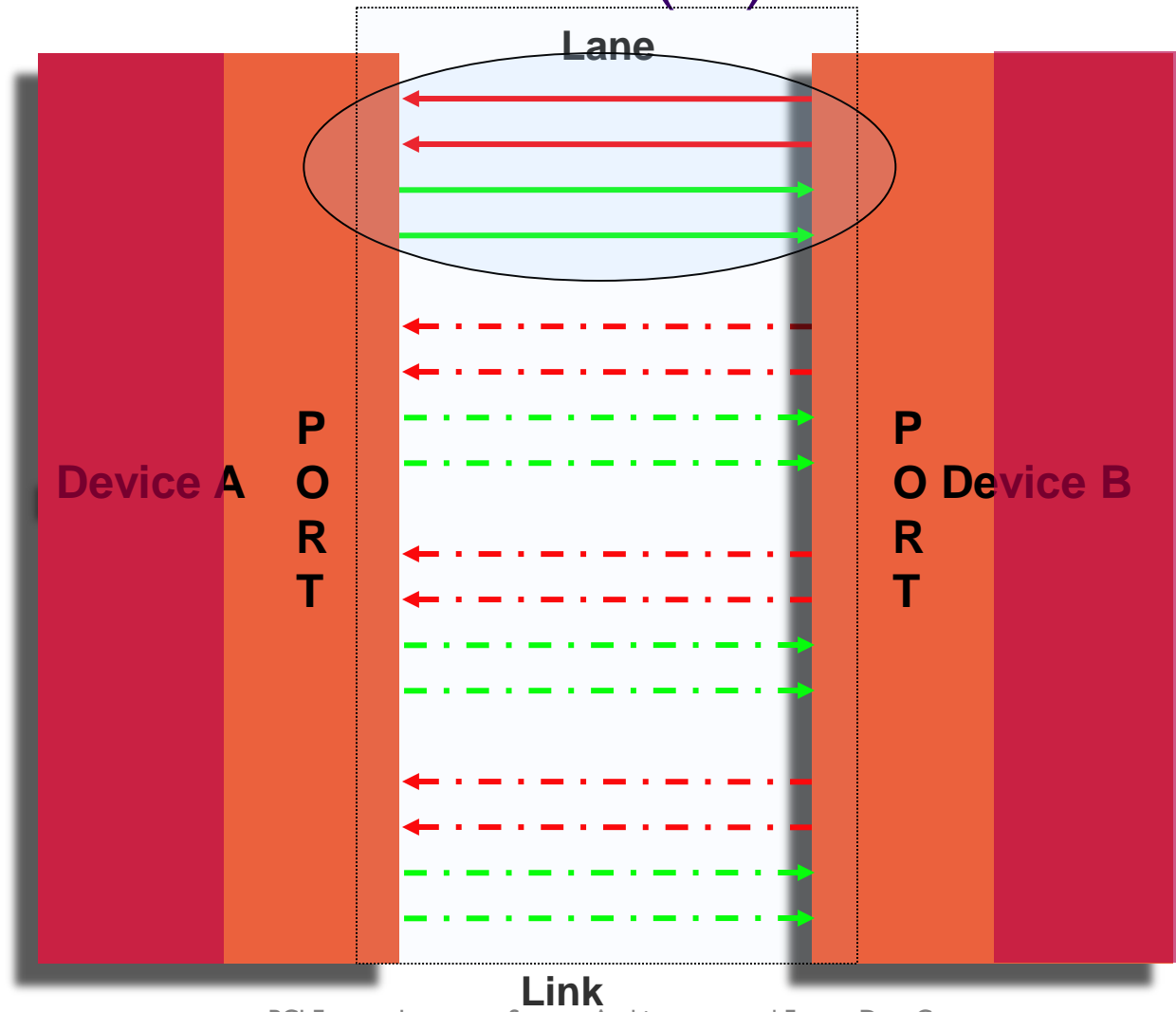

PCI Express Terminology

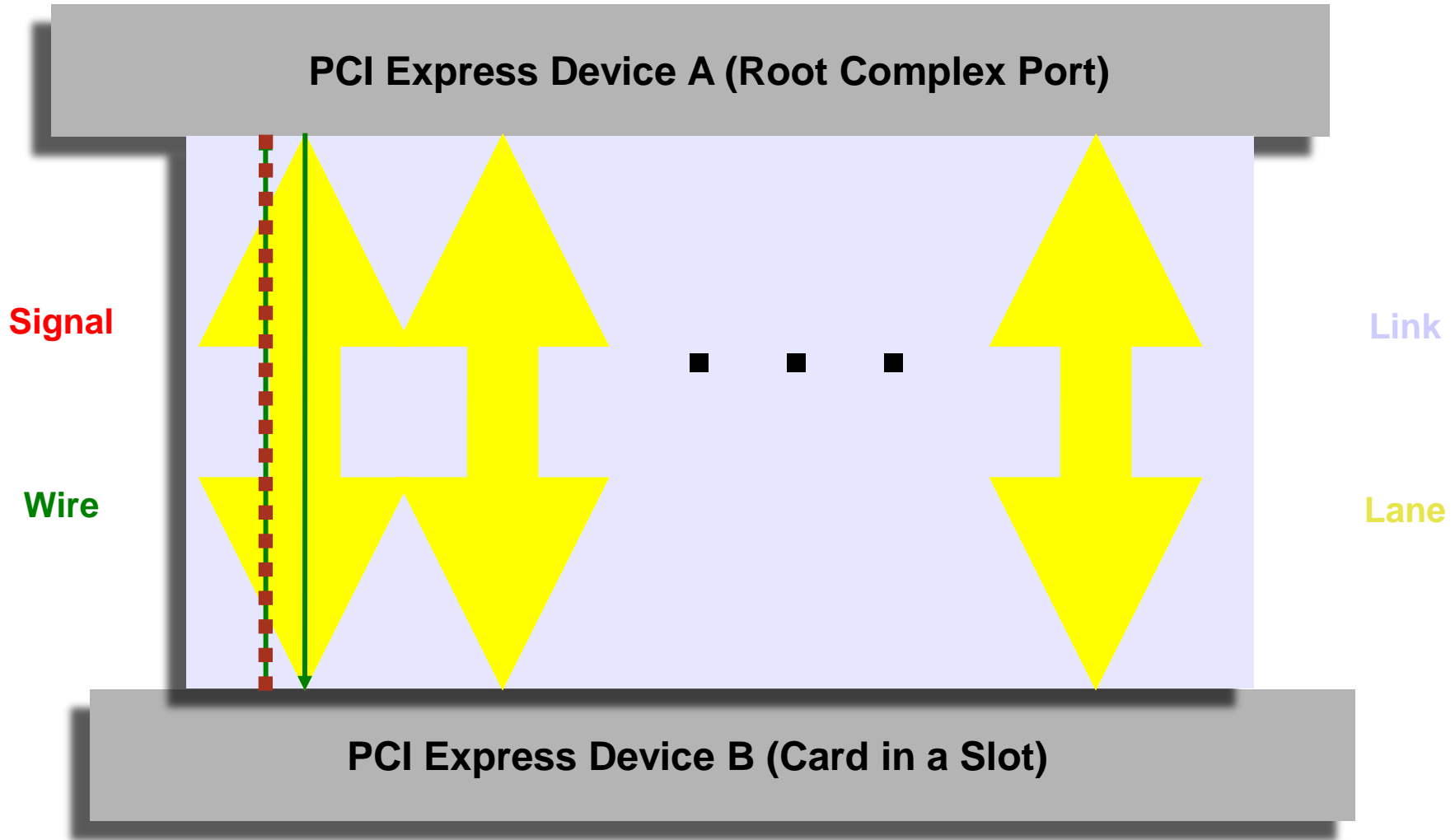

Transaction Types

Requests are translated to one of four types by the Transaction Layer:

- **Memory Read or Memory Write**
 - ◆ Used to transfer data to or from a memory mapped location. Protocol also supports a locked memory read transaction variant.
- **IO Read or IO Write**
 - ◆ Used to transfer data to or from an IO location
 - ◆ These transactions are restricted to supporting legacy endpoint devices.

Requests can also be translated to:

- **Configuration Read or Configuration Write:**
 - ◆ Used to discover device capabilities, program features, and check status in the 4KB PCI Express configuration space.
- **Messages**
 - ◆ Handled like posted writes. Used for event signalling and general purpose messaging.

PCI Express Throughput

Link Width		X1	X2	X4	X8	X16	X32
Aggregate BW (Gbytes/s)	Gen1 (2004)	0.5	1	2	4	8	16
	Gen2 (2007)	1	N/A	4	8	16	32
	Gen3 (2010)	2	N/A	8	16	32	64

- Assumes 2.5 GT/sec signalling for Gen1
- Assumes 5 GT/sec signalling for Gen2
 - ◆ 80% BW available due to 8 / 10 bit encoding overhead
- Assumes 8 GT/sec signalling for Gen3

Aggregate bandwidth implies simultaneous traffic in both directions
Peak bandwidth is higher than any bus available

PCI-X vs PCIe Throughput

How does PCI-X compare to PCI Express?

PCI-X vs PCI Express

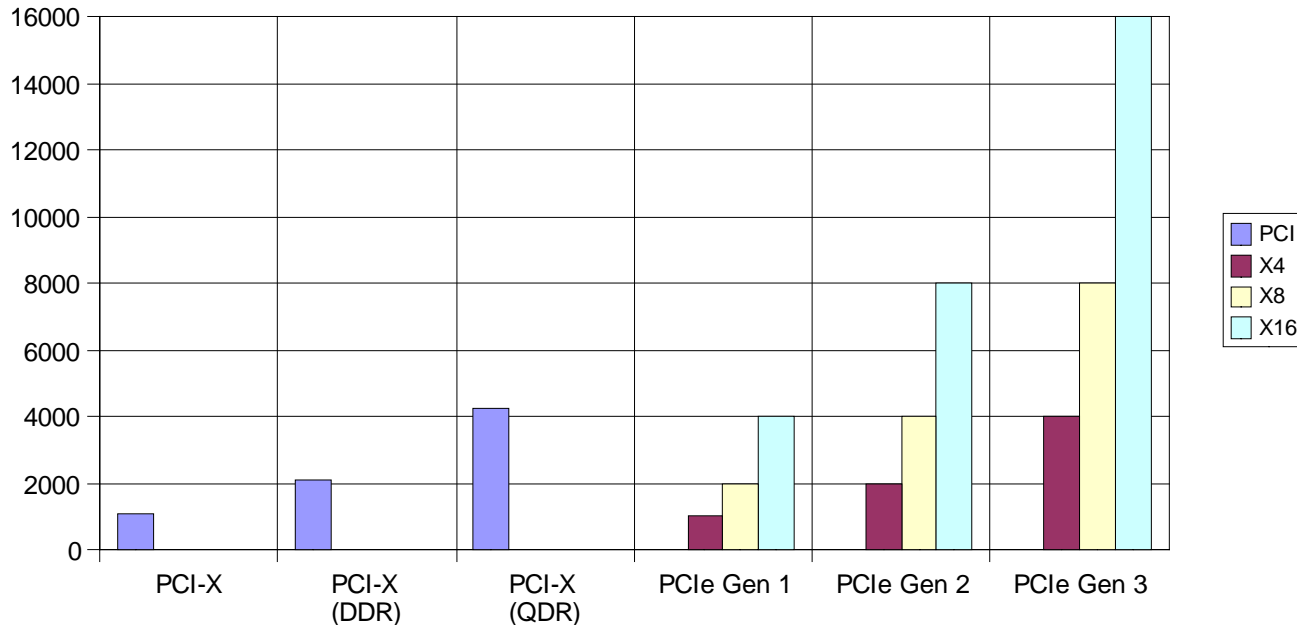

- PCI-X QDR maxs out at 4263 MB/s per leaf
- PCIe x16 Gen1 maxs out at 4000 MB/s
- PCIe x16 Gen3 maxs out at 16000 MB/s

PCI Express Bandwidth

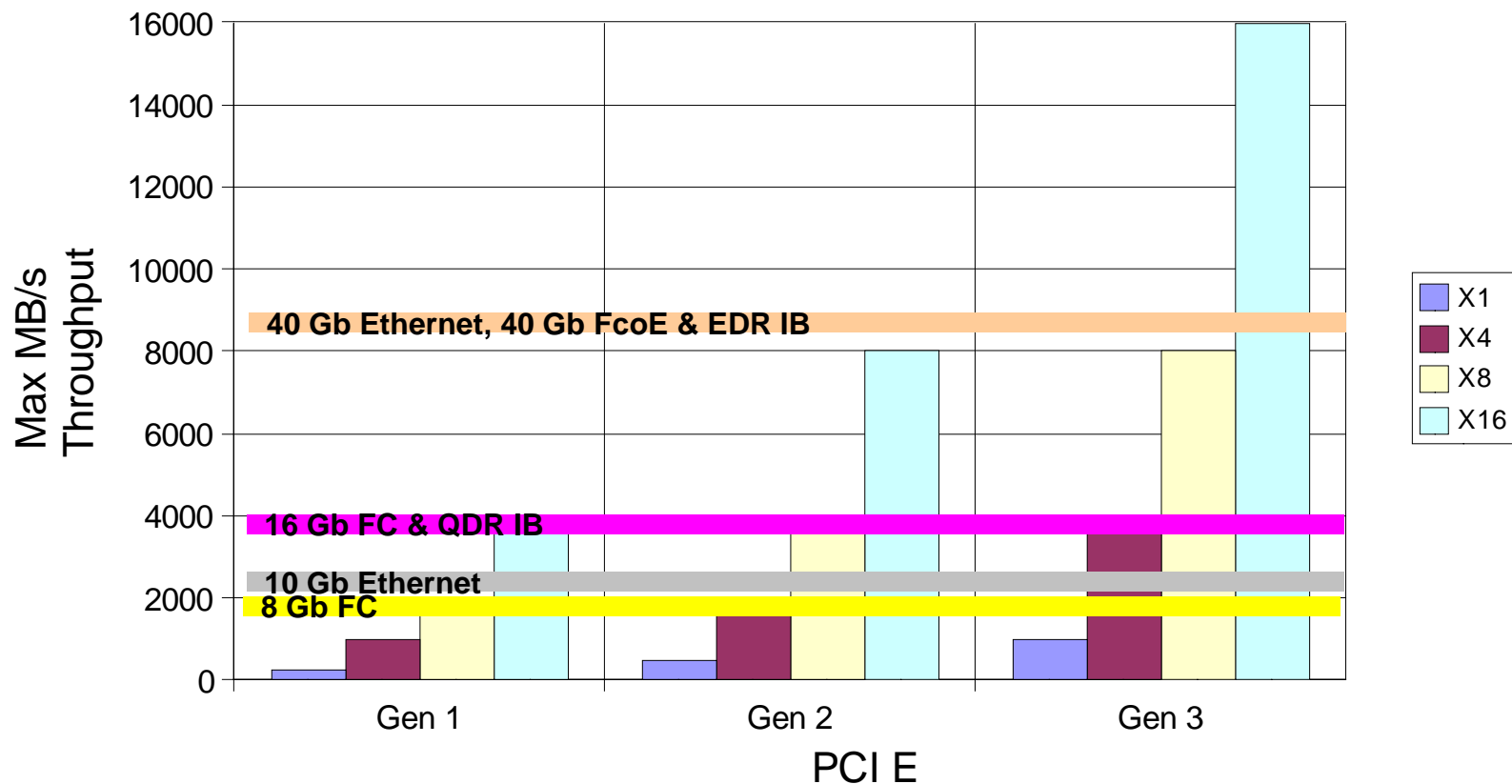

Sample PCI Express Topology

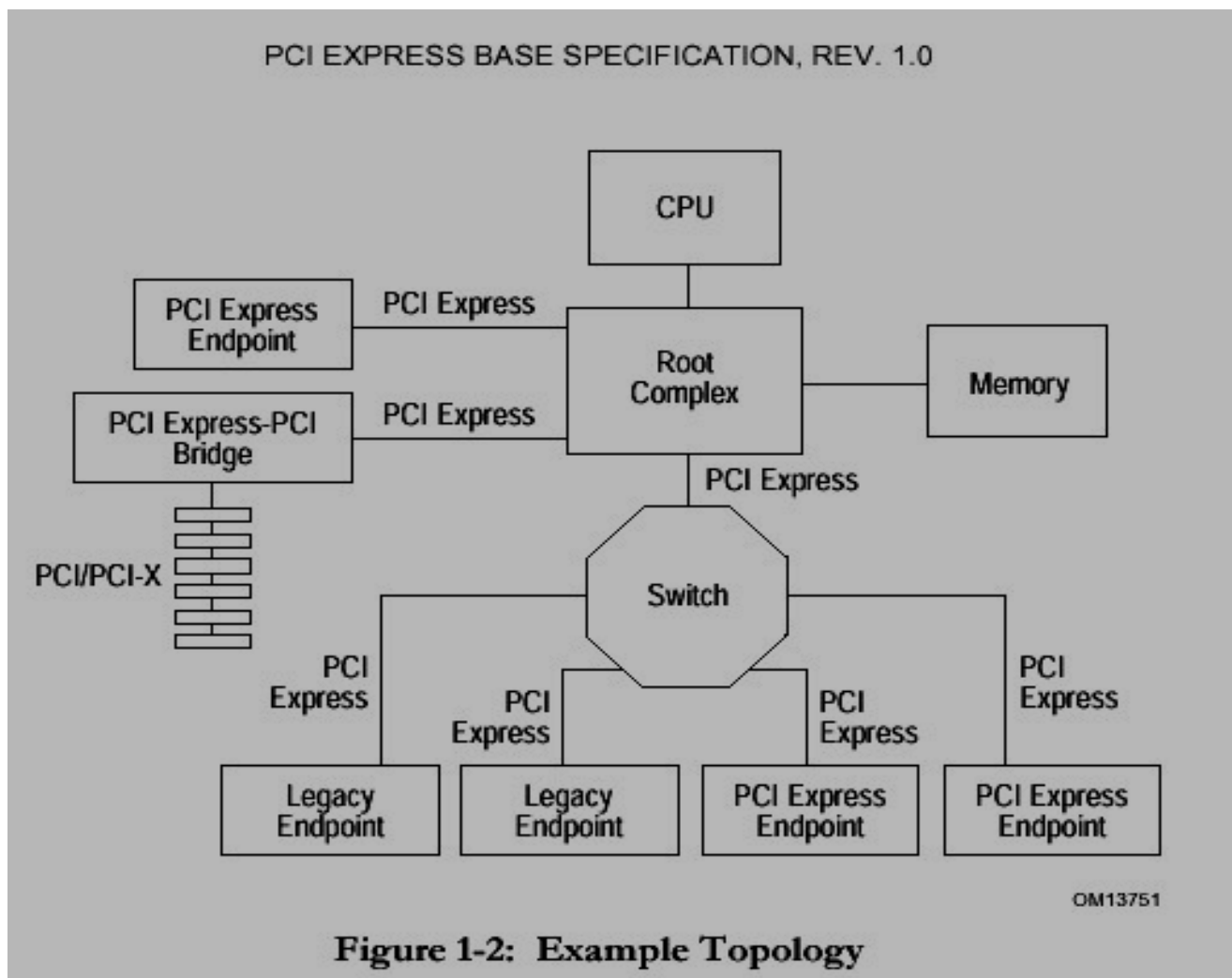

Benefits of PCI Express

- **Lane expansion to match need**
 - ◆ x1 Low Cost Simple Connector
 - ◆ x4 or x8 PCIe Adapter Cards
 - ◆ x16 PCIe High Performance Graphics Cards
- **Point- to- Point Interconnect allows for:**
 - ◆ Extend PCIe via signal conditioners and repeaters
 - ◆ Optical & Copper cabling to remote chassis
 - ◆ External Graphics solutions
 - ◆ External IO Expansion
- **Infrastructure is in Place**
 - ◆ PCIe Switches and Bridges
 - ◆ Signal Conditioners

PCI Express at the SIG (Gen 1)

- PCIe Gen 1.1
 - ◆ Approved 2004/2005
 - › Frequency of 2.5 GT/s per Lane Full Duplex (FD)
 - › Use 8/10 Bit Encoding => 250 MB/s/lane (FD)
 - › $2.5 \text{ GT} @ 1 \text{ bit/T} * 8/10 \text{ encoding} / 8 \text{ bit/byte} = 250 \text{ MB/s FD}$
 - › PCIe Overhead of 20% yields 200 MB/s/lane (FD)
 - › Replace PCI-X DDR and QDR Roadmap
 - › Defined Switches, Bridges and Devices
 - › x16 High Performance Graphics @ 50W (then 75W)
 - › x8, x4, x1 Connectors
 - › (x8 is pronounced as by 8)
 - › Support your lane width and all lower lane widths
 - › Defined Express Module

PCI Express In Industry

- **PCIe Gen 2.0 Shipped in 2008**
 - ◆ Approved 2007
 - › Frequency of 5.0 GT/s per Lane
 - › Doubled the Theoretical BW to 500 MB/s/lane 4 GB per x8
 - › Still used 8/10 bit encoding
 - › Support for Genesco features added (details later)
 - › Power for x16 increased to 225W
 - ◆ Desktop systems started Gen2 x16 slots in Q4 2007
 - ◆ Servers shipping slots 2009
- **Cards Available**
 - ◆ x4, x8 cards – Single/Dual 10 GbE, Dual/Quad GbE, Single/Dual 10 Gb CNA, Single/Dual 4/8 Gb FC, SAS 2.0, IB QDR, Serial Cards, Other Special Cards
 - ◆ x16 High Performance Graphics @ 150W and more
 - ◆ Old PCI technology behind PCIe-PCIX bridge

- **PCIe Gen 3.0**

Base Spec currently at 1.0 (as of Dec 2010)

- › Frequency of 8.0 GT/s per Lane
- › Uses 128/130 bit encoding / scrambling
- › Nearly Doubled the Theoretical BW to 1000 MB/s/lane
- › Support for Genesco features included

Standard for Co-processors, Accelerators, Encryption,
Visualization, Mathematical Modeling, Tunneling

- › Power for x16 increased to 300W
(250 W via additional connector)

- ◆ Express Module Spec is being upgraded to Gen2 then to Gen3
 - › Ron Emerick is the current chair of the EM working group

- **External expansion**

- ◆ Cable work group is active

- **PCIe IO Virtualization (SR / MR IOV)**

- ◆ Architecture allows shared bandwidth

PCI Express In Industry

- **PCIe Gen 3 Will Ship in 2011**
 - ◆ Desktop Systems
 - › x16 High Performance Graphics
 - ◆ Servers with multiple x4 and x8 connectors in 2012
 - ◆ Root Complex's will provide multiple x8, less need for switches
- **First Gen3 Cards Available 2011/2012**
 - ◆ Dual 10 Gb CNAs/FC boards (multi personality)
 - ◆ SAS 2.0 16 port, SAS 3.0 8/16 port
 - ◆ x16 High Performance Graphics @ 300 W and more
 - ◆ FDR/EDR InfiniBand
 - ◆ Dual/Quad 10 Gbase-T and Optical
 - ◆ Single/Dual 40 Gb, FCoE, iSCSI, NAS

New IO Interfaces

- High Speed / High Bandwidth
 - Fibre channel – 8 Gb, 16 Gb, 32 Gb , FCoE
 - Storage area network standard
 - Ethernet – 10Gb, 40Gb, 100Gb
 - Provides a network based solution to SANs
 - InfiniBand - QDR, FDR, EDR
 - Choice for high speed process to processor links
 - Supports wide and fast data channels
 - SAS 2.0, 3.0 (6 Gb, 12 Gb)
 - Serial version of SCSI offers low cost storage solution
 - SSDs
 - Solid State Disk Drive Formfactor
 - Solid State PCIe Cards
 - Solid State Iru Trays of Flash

- **Processor speed increase slowing**
 - Replaced by Multi-core Processors
 - Quad-core here, 8 and 16 core coming
 - Requires new root complex architectures
- **Requires high speed interface for interconnect**
 - Minimum 10Gb data rates, moving higher
 - Must support backplane distances
 - Bladed systems
 - Single box clustered processors
 - Need backplane reach, cost effective interface to IO
- **Interface speeds are increasing**
 - Ethernet moving from GbE to 10G, FC from 8 Gb to 16 Gb, Infiniband is now QDR with FDR and EDR coming
 - Single applications struggle to fill these links
 - Requires applications to share these links

- **High Availability Increasing in Importance**
 - Requires duplicated processors, IO modules and interconnect
 - Use of shared virtual IO simplifies and reduces costs and power
 - Shared IO support N+1 redundancy for IO, power and cooling
 - Remotely re-configurable solutions can help reduce operating cost
 - Hot plug of cards and cables provide ease of maintenance
 - PCI Express Modules with IOV enable this
- **Growth in backplane connected blades and clusters**
 - Blade centres from multiple vendors
 - Storage and server clusters
 - Storage Bridge Bay hot plug processor module
 - PCI Express IOV allows commodity I/O to be used

Share the IO Components

PCIe IOV Provides this Sharing

- Root Complexes are PCIe
 - Closer to CPU than 10 GbE or IB
 - Requires Root Complex SW Modifications
- Based Upon PCI SIG Standards
- Allows the Sharing of High Bandwidth, High Speed IO Devices

Single Root IOV

Better IO Virtualization for Virtual Machines

System I/O with a Hypervisor

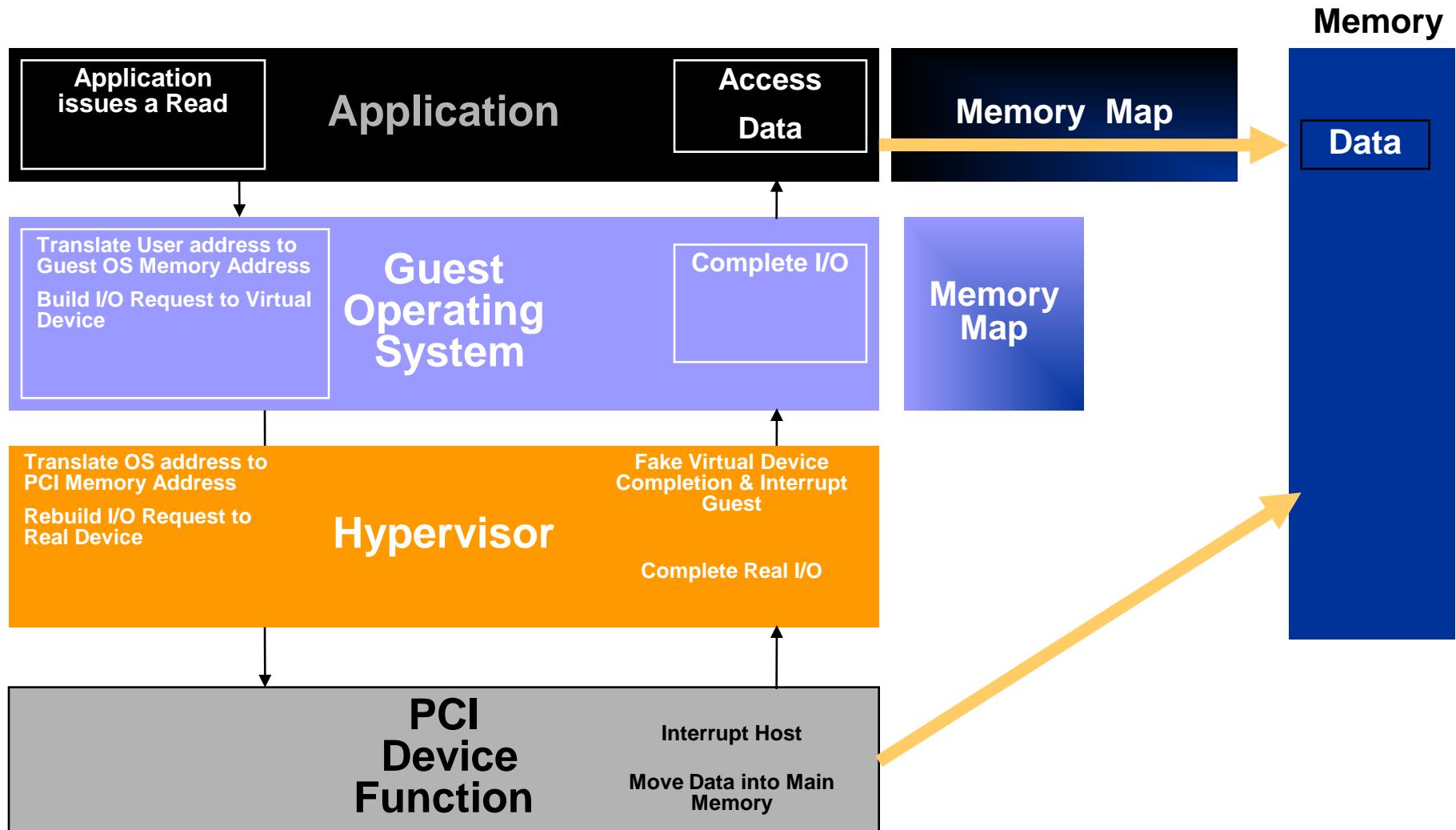

Single Root IOV

- Before Single Root IOV the Hypervisor was responsible for creating virtual IO adapters for a Virtual Machine
- This can greatly impact Performance
 - Especially Ethernet but also Storage (FC & SAS)
- Single Root IOV pushes much of the SW overhead into the IO adapter
 - Remove Hypervisor from IO Performance Path
- Leads to Improved Performance for Guest OS applications

PCI-SIG Single Root

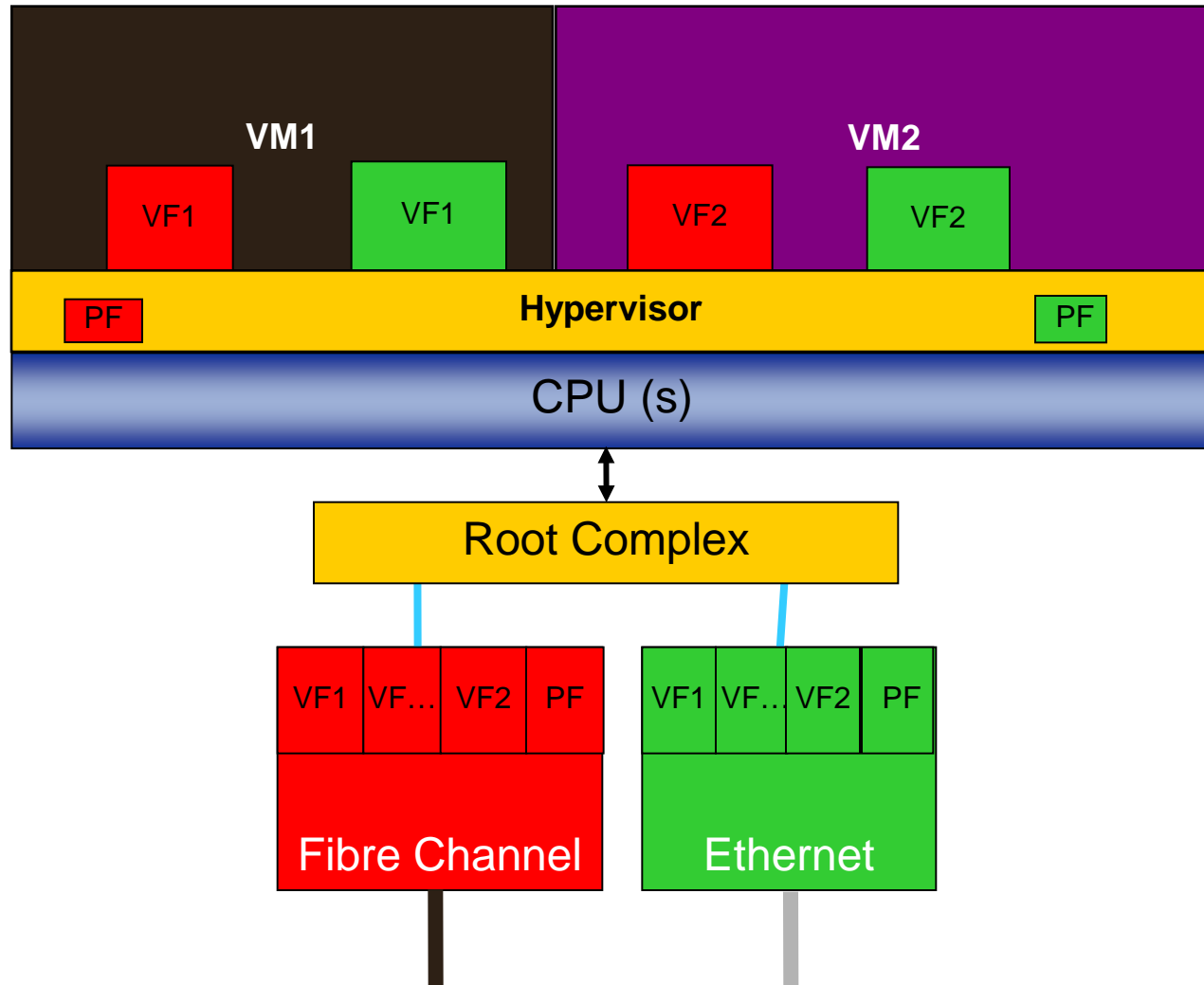

Fibre Channel & SR Virtualization

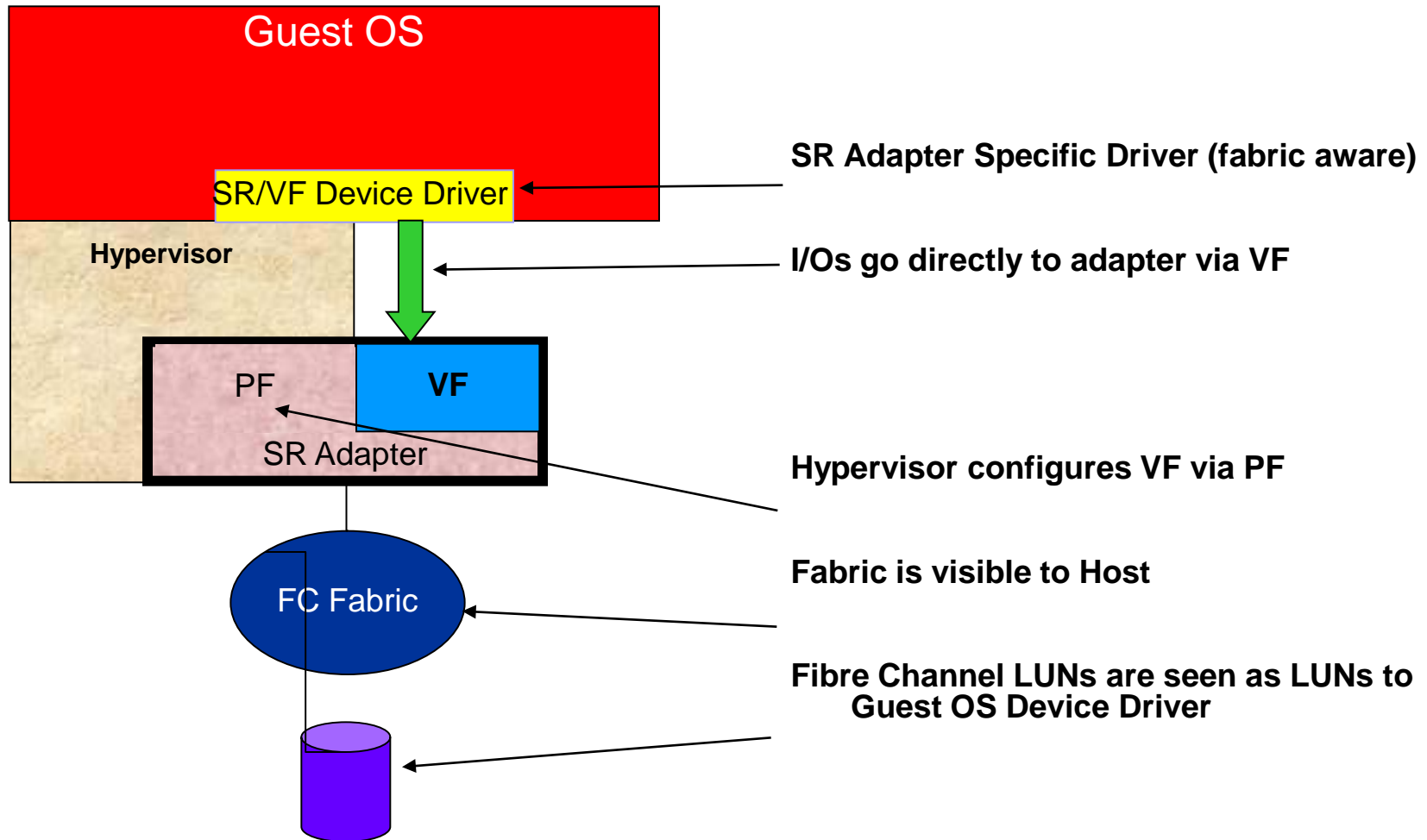

Roll Out of IOV

- **Blade Chassis are First to Roll Out SR IOV**
 - Limited IO Slots
 - Space Constraints
 - Discouraged by OS Uniqueness
- **Servers in 2010**
 - SR IOV
 - Especially Ethernet but also Storage (FC & SAS)
- **MR IOV**
 - No Offerings Yet
 - Great for Blades Sharing High Speed/Bandwidth Ports
 - Each OS must work with IOV Management Layer

- **PCI Express provides**
 - Full Bandwidth Dual Ported 8 & 16 Gb FC
 - Full Bandwidth for QDR, FDR and EDR IB
 - Full Bandwidth SAS 2.0 & 3.0
 - Legacy Support via PCI-X
- **IOV takes it one step further**
 - Ability for System Images to Share IO across OS Images
 - Backplane for Bladed Environments
- **Extension of PCIe**
 - Possible PCIe attached storage devices

What Your Next Data Center Might Look Like

Data Center in 2013-2016

- **Root complexes are PCIe 3.0**
 - ◆ Integrated into CPU
 - ◆ Multiple Gen3 x8 from each socket
 - ◆ Multicast and Tunneling
 - ◆ PCIe Gen4 in 2016 and beyond
- **Networking**
 - ◆ Dual ported Optical 40 GbE (capable of FCoE, iSCSI, NAS)
 - ◆ 100 GbE Switch Backbones by 2018
 - ◆ Quad 10 Gbase-T and Quad MMF (single ASIC)
 - ◆ Dual/Quad Legacy GbE Copper and Optical
 - ◆ Dual ported FDR & EDR InfiniBand for cluster, some storage
- **Graphics**
 - ◆ x16 Single/Dual ported Graphics cards @ 300 W (when needed)

Data Center in 2013-2016 (2)

- **Storage Access**
 - ◆ SAS 3.0 HBAs, 8 and 16 port IOC/ROC
 - ◆ 16/32 Gb FC HBAs pluggable optics for single/dual port
 - ◆ Multi-function FC & CNA (converged network adapters) at 16/32 Gb FC and 40 Gb FCoE
- **Storage will be:**
 - ◆ Solid State Storage
 - › SSS PCIe Cards, 1 ru trays of FLASH DIMMS
 - › SSS in 2.5" and 3.5" drive formfactor following all current disk drive support models
 - ◆ 2.5" and 3.5" 10K RPM SAS (capacities up to 1 to 2 TB)
 - ◆ 2.5" and 3.5" SATA 2.0 Drives (capacities 500 GB to 4 TB)
 - ◆ SAS 3.0 Disk Arrays Front Ends with above drives
 - ◆ 16/32 Gb FC Disk Arrays with above drives
 - ◆ FDR/EDR IB Storage Heads with above drives

Future Storage Attach Model

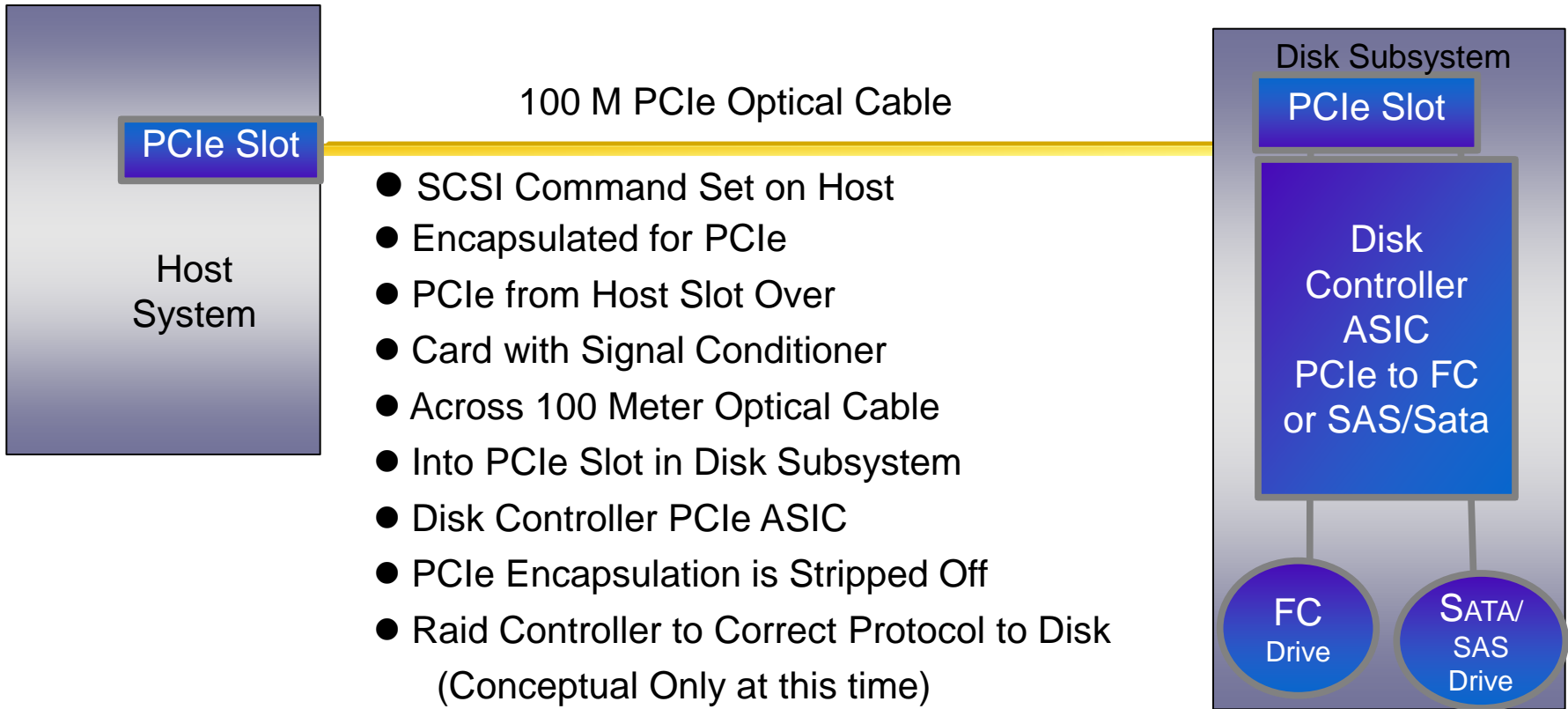

PCI – Peripheral Component Interconnect. An open, versatile IO technology. Speeds range from 33 Mhz to 266 Mhz, with pay loads of 32 and 64 bit. Theoretical data transfer rates from 133 MB/ s to 2131 MB/ s.

PCI-SIG - Peripheral Component Interconnect Special Interest Group, organized in 1992 as a body of key industry players united in the goal of developing and promoting the PCI specification.

IB – InfiniBand, a specification defined by the InfiniBand Trade Association that describes a channel-based, switched fabric architecture.

Root complex – the head of the connection from the PCI Express IO system to the CPU and memory.

HBA – Host Bus Adapter.

IOV – IO Virtualization

Single root complex IOV – Sharing an IO resource between multiple operating systems on a HW Domain

Multi root complex IOV – Sharing an IO resource between multiple operating systems on multiple HW Domains

VF – Virtual Function

PF – Physical Function

- Please send any questions or comments on this presentation to SNIA:
tracknetworking@snia.org

**Many thanks to the following individuals
for their contributions to this tutorial.**

SNIA Education Committee

**Alex Nicolson
PCI SIG Members**